



Don't Get Hosed!

By High Online Advertising Costs!

Small Ads Typeset and Posted Online

25 Words: 1 Inch \$1+1 FCS

50 Words: 2 Inch \$2+1 FCS

Ads received will be posted on a high traffic website the following Monday. Acknowledgment sent with Six Copies of your new ad. Order Today!

Dan Gill

P O Box 65 Round Rock, TX 78680

<http://www.dangillwebads.com>



FREE INFORMATION
 INVEST ONLY \$25 Gross \$1000
 Send SASE & AD to:
Kofi T
 2572 Wallace Ave #4G Bronx, NY 10467

1950 Buick Roadmaster Sedan
 Automatic Been sitting
 \$2000 Firm
 Call (570) 538-3464
 Pennsylvania



1970 Ford Maverick 2 Door, 38K Orig.
 Miles. Kept in storage 3 years.
 Needs to be restored.
 \$3000 (256) 453-2623
 Alabama



FREE INFO
 Invest \$5 Gross \$120 Send SASE & AD to:
Kofi T
 2572 Wallace Ave #4G Bronx, NY 10467

1978 Dodge Motorhome Truck
 (Unusual, Long-Hood Model) Tandem
 -Axle. 21 Ft, 318 V8 (much stripped
 inside) \$1,500
 (608) 582-2263 Wisconsin



1947 Studebaker Champion 4 Door,
 6 cyl, 3 spd-Runs, New Tires too!
 \$3,200 / OBO
 Maxx D'Cruz
 (520) 254-2422 Arizona



**Big Mails
 Wanted**
 I read them all.
 Thank you.
Harold Scharff
 2410 Barker Ave Suite 2B
 Bronx, NY 10467-7632

1988 Buick
 LaSabre Hearse, 
 307 V8, Auto, PS,
 PB, AC, PW \$3700
 (417) 343-6354 Missouri

1984 Jaguar XJ12 139K Miles \$1,250.
 1985 Mercedes Benz and 300 SD runs
 Smooth \$800.
 Both need work. Call
 (207) 745-6883 Maine



Your Full Page Single-
 Sided Flyer printed &
 mailed as a 5x7 color
 display in my next
 available adsheet \$8.00
 Bonus Posting Online!
Dan Gill
 P O Box 65
 Round Rock, TX 78680

LIVE GOOD
 We are looking for 20 people to
 help us expand our business.
 Earn up to \$2,000 a month.
 Flex Hours and Work From Home!
LIVEGOODTOUR.COM/ZARDOT77

WANT MORE RESPONSES TO YOUR MAILINGS?

You need our Exclusive Priority Envelopes!

That's Right!

These beautifully designed
Priority Envelopes stand out!

Printed with beautiful
"eye-catching" teal ink and
impressive artwork.



Smart marketer's know that a direct mail piece
MUST include an Eye Catching Envelope.

**You will gain more responses and higher
conversion rates using these envelopes!**

"Pique" The Interest Of Your Recipients!

Whether you're an Opportunity, MLM or Postcard Mailer, these envelopes are proven to increase your orders. They give an "Authentic Touch" to the credibility of an offer.

People have told us that responses and conversion rates
on their orders have substantially increased!

Order Now!

These exclusive envelopes are available in packs of 100 for only \$20.00 (\$5.00 S&H on each order).
A small investment for a potentially High Return!

Orders received with Cash, Money Orders or Credit Card receive FAST Same Day Shipping.
Personal checks welcome (allow 21 day clearance).

Mail Orders to:

MCG MEDIA, INC.

1229 Chestnut St., Suite 239, Philadelphia, PA 19107

Email Credit Card Orders to: grassmavin@gmail.com

Fax Orders to: 267-609-6431

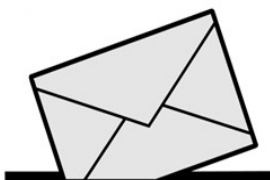

Note: Please be sure to include complete
credit card number, expiration date, and 3 digit
code. Also include your phone number.



500 STAMPS AND LEADS



ONLY \$100

(A Huge Savings of \$275 Off Retail Prices)



Everyone in the Mail Order Business knows that Stamps and Leads are our Biggest Expense or at least it was, because now it's **NOT** with this Limited Time Special Offer, we can supply You with 500 First Class Stamps and 500 Fresh Opportunity Seeker Leads on Peel-n-Stick Labels for Only \$100 with Free Shipping, so take Advantage of these Huge Savings and place your Order Today!

FREE SPECIAL BONUS GIFT

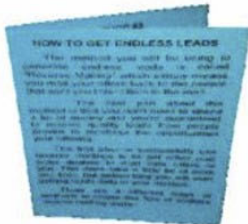

As a Free Bonus we will give you a copy of our new report titled "How To Get Endless Leads", which will teach you about 3 different methods to generate unlimited free opportunity seeker and buyer leads, so don't miss out on this Free Gift, fill out the order form below and return it with your Cash or Money Order payment of \$100 Now!

You Can Also Place Your Order by Sending \$100 by CashApp to: **\$MailboxBenjamins**
After making payment by CashApp, please send us an email or text with your name, mailing address and the ID# below.

ORDER FORM

YES! I'm ready to order my 500 First Class Stamps, 500 Business Opportunity Seeker Leads and my Free Bonus Report now, so enclosed is my \$100 CASH or MONEY ORDER payment.

Please Print Your Info Below Clearly

NAME: _____

ADDRESS: _____

CITY: _____

STATE: _____ ZIP: _____

PHONE#: _____

EMAIL: _____

Pay \$100 by CashApp To:
\$MailboxBenjamins

SEND THIS ORDER FORM AND PAYMENT TO:

MARKETING ADVANTAGE
15 Hillcrest Dr
Bloomfield, NY 14469
(585) 820-4463
JoinTeamMartin@gmail.com

ID# 868

NOTE: Please Allow 7-10 Days for Delivery. All Right Reserved © Marketing Advantage 2023



www.lottocash.club

**Lottoday Gaming NFTs How To
Earn Revenue Share From
Global Lottery Up To 10X
Payout! (\$10M Sold Out)**

**Contact: Daryl ID 241548
913-951-1276**

August 2023

**Take a FREE Tour of our “Life Changing”
Holistic Health Products at Wholesale Prices**

www.livegoodtour.com/cloud9cowboy

**Learn about the 4 Major
Causes of Disease Here**

www.200diseases.com

**The Good News is, we have “Life Changing”
Holistic Health Products at wholesale prices.**

Take a Free Tour Here

www.livegoodtour.com/cloud9cowboy

**The Good Image TEAM Integrity Group
563 River St.
Newport, TN 37821-3269**

**Whatever your situation or scenario, we have what you
need to succeed, Guaranteed!**

allsolutionsnetwork.com/JS/JS548260



KEEP IT 100

WWW.I KEEPIT100.COM

NO COMPUTER? NO PROBLEM! CALL, LISTEN & LEARN 24/7!

720-740-9898 Enter Access Code 1808851 Then Press # & Press # Again.

YOU KEEP 100% OF WHAT YOU PAY!

Pay \$100 / Keep \$100 / Per \$100 Sale / 10=\$1,000!

Pay \$200 / Keep \$200 / Per \$200 Sale / 10=\$2,000!

Pay \$500 / Keep \$500 / Per \$500 Sale / 10=\$5,000!

Pay \$1,000 / Keep \$1,000 / Per \$1,000 Sale / 10=\$10,000!

Pay \$2,000 / Keep \$2,000 / Per \$2,000 Sale / 10=\$20,000!

Pay \$5,000 / Keep \$5,000 / Per \$5,000 Sale / 10=\$50,000!

Pay \$10,000 / Keep \$10,000 / Per \$10,000 Sale / 10=\$100,000!

Ashcor WE PAY DAILY! Since 2017

We sell **Subscriptions** that contain **Income Opportunity Seeker Leads** on CD-ROM. Flash Drive option available **How To Get Rich In Mail Order Publications** Up To 7 Volumes. Plus, **Done 4-U Mailing And Marketing Service.**

<u>S1 = 1,000</u>	<u>Leads—1 Vol.—10</u>	<u>Mailings—Cost \$100</u>	<u>+ \$50 Admin</u>
<u>S2 = 2,000</u>	<u>Leads—2 Vols.—20</u>	<u>Mailings—Cost \$200</u>	<u>+ \$100 Admin</u>
<u>S3 = 5,000</u>	<u>Leads—3 Vols.—40</u>	<u>Mailings—Cost \$500</u>	<u>+ \$250 Admin</u>
<u>S4 = 10,000</u>	<u>Leads—4 Vols.—100</u>	<u>Mailings—Cost \$1,000</u>	<u>+ \$500 Admin</u>
<u>S5 = 100,000</u>	<u>Leads—5 Vols.—200</u>	<u>Mailings—Cost \$2,000</u>	<u>+ \$1,000 Admin</u>
<u>S6 = 200,000</u>	<u>Leads—6 Vols.—400</u>	<u>Mailings—Cost \$5,000</u>	<u>+ \$2,500 Admin</u>
<u>S7 = 500,000</u>	<u>Leads—7 Vols.—1,000</u>	<u>Mailings—Cost \$10,000</u>	<u>+ \$5,000 Admin</u>

Purchase the subscription you desire and choose to become an affiliate and you'll earn **100%** of the cost of your subscription and **100%** on lower subscriptions!

Plus, you'll earn **100%** of your subscription on *higher subscriptions!*

Plus an extra **10% POWER BONUS** of *higher subscriptions!*

Don't Delay. Order Today! Fill The Blanks Below. Sign, Date & Return ASAP!

Name _____
Address _____
City _____ State _____ Zip Code _____
Email _____ Tel. _____

Yes! I'm Ordering Subscription # S Today!.....

Yes! (Optional) I Want To Be An Affiliate Also With My Purchase Today! Fees on all card purchases..

All Sales Are Final NO Refunds And I WILL NOT Perform A Charge Back On Ashcor.

REQUIRED Sign _____ **Date** _____

Need More Mailing? Ask About Our LOW COST Print-N-Mail Services!

Mail To: ASHCOR P.O. BOX 2022 DULUTH, GA 30096 TEL. 678-437-9890

16-2 Steven Owen Call Me! 913-396-1337

You must be 18 or older. There Are NO REFUNDS/NO GUARANTEES OF INCOME/ALL SALES ARE FINAL. Affiliates earning \$600 or more will receive a 1099 tax form by law. Customers/Affiliates deemed damaging to ASHCOR will be terminated. You will not compete against nor hold ASHCOR, it's owner, liable legally or in any way for anything ever. ASHCOR reserves the right to alter, change or cancel any part of this promotion without notice. Leads and Publications are sold as is with NO guarantees. Your efforts could determine your success. Void where prohibited by law. All rights reserved. Copyright 2023 ASHCOR.

First Class Print & Mail

We will P&M Your 8x11”
Circulars & Adsheets For Only

- 600 Copies \$ 20 + 20 F/C Stamps
- 6000 Copies \$150 + 150 F/C Stamps
- 16,000 Copies \$300 + 300 F/C Stamps
- 60,000 Copies \$1500 + 1500 F/C Stamps

▶▶ Bonus #1: Send out 16,000 copies and we mail up to 10,000 of your postcards FREE

▶▶ Bonus #2: Send out 6000 copies or more and join three programs FREE

▶▶ Earn up to \$7,280,000

All adsheet customers receive Free C/C. Return this ad with order to:

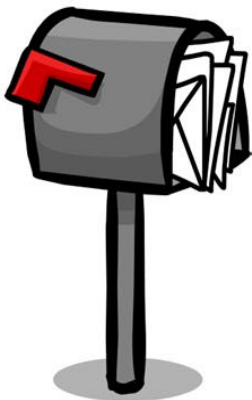

William Marshall
P O Box 230751
Boston, MA 02123

If You See This Flyer ANYWHERE

Imagine Your Mail BOX

FLOODED WITH \$20.00 BILLS

Exciting NEW Flyer Brings You \$20.00 Orders

You KEEP ALL The MONEY!



This One Is 100% All-Profit!



It's A Business So Simple Anyone Can Make MONEY with It!

A Prime Source needs new names to mail his offers to. And with this exciting Dealership

YOU can earn \$20.00 for every name you collect using this brand new circular.

When the \$20.00 orders flood your Mailbox, YOU KEEP ALL THE MONEY! Simply send this Circular with your customers' name and address on it and 5 f/c stamps to the Prime Source.

The Prime Source will do the rest.

OK! I want to start earning my \$20 All-Profit as your Name Broker. I'm enclosing THIS circular, \$20.00 and 5 (unused) F/C stamps.

Broker: **Larry L. Mann**

P.O. Box 497 ~ Bell Buckle TN 37020

Name _____

Address _____

City/State/Zip _____



Please Return It

With \$20.00 Plus 5 f/c Stamps To:

Larry L. Mann

P.O. Box 497 ~ Bell Buckle TN 37020

5 PUBLICATIONS

1500 Circulation Each

7500 Total Circulation

Your Ads Placed in 5 Adsheets

\$40 per Inch

8x11 as 5x7" \$80 each

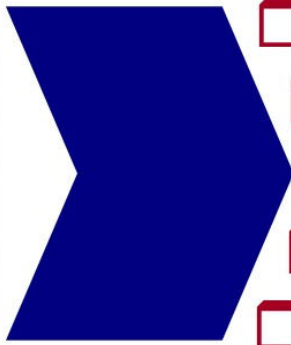

The Unicorn Adsheet

USS Alabama Adsheet

Low Moon Adsheet

Cat Press Adsheet

The Dishwashers Adsheet

Please send One Ad for EACH Publication

5 Free Checking Copies

William Marshall

P O Box 230751

Boston, MA 02123

Bonus: Send up to 2500 copies of your 8x11" flyers or postcards to be mailed free.

Same or different.

If You See This Flyer ANYWHERE

WHY WAIT?
Retire Early
Get Paid CASH Everyday 
For the Rest of Your LIFE!
Pay a small One-Time lifetime Fee!
You'll NEVER Have to Pay Again!

Keep Mailing Your Flyer
Then Open Your Mail! 
This is a lifetime Opportunity
That will last Your lifetime!
Add Your Spouse to Double Your CASH Income!
Pays Your Survivors CASH after you pass on!

GET STARTED FAST

Send \$10.00 Cash + 5 f/c stamps for Set-up
(Dealer Keeps the \$10 Sends 5 f/c stamps to prime source)

Name _____
Address _____
City/State/Zip _____

Return Flyer with order
Barry L. Mann
P.O. Box 497
Bell Buckle TN 37020
Copyright 2019, LLM (Dm-199)



Please Return It
With \$10.00 Plus 5 f/c Stamps To:
Barry L. Mann
P.O. Box 497 ~ Bell Buckle TN 37020



JACKPOT!

RECEIVE UNLIMITED LOTTERY SCRATCH-OFF TICKETS & WINNINGS FOR LIFE!

A MONTHLY PROGRAM FOR SERIOUS-MINDED LOTTERY PLAYERS!

Here are the exciting details...

Your total cost to join is only **\$35.00** in tickets and cash. Your cost to participate and receive tickets and cash is **\$30.00 MONTHLY**. If you cannot afford a measly \$30.00 for the chance to receive hundreds or even thousands of Lottery Scratch-Off Tickets each month; or, if you will not keep a monthly commitment; this is **NOT** the program for you! We are looking for serious members who want **LOTS** of **TICKETS** and **CASH** pouring in each and every month residually, for life! If that is for you, then by all means read on! There are 3 member positions below. Send each member a \$1.00, a \$2.00, and a \$5.00 unscratched lottery ticket, plus \$2.00 CASH. Then send the Program Editor \$5.00 CASH for your Master Copies in black & white + color. That is all there is to it!!!

On the 1st of every month, send each member the same amount of tickets and cash. The Program Editor fee is NOT monthly, but is a one-time cost to set up & mail your Master Copies. **Each person only sponsoring 10 people would be a whopping 1,110 of EACH denomination of tickets, plus \$2,220.00 in cash monthly!** Rush your scratch-off tickets & CASH to each of the following 3 members & \$5.00 CASH Editor listed below:

1. Thom Houston, 1403 Brandon Ct., Bay City, TX 77414
2. Remi E. Byrd, 2318 Candace St., Pittsburgh, PA 15216
3. David Bowker, 1002 9th Ave., New Brighton, PA 15066

EDITOR: PAM BUDD, 2318 CANDACE ST., PITTSBURGH, PA 15216



DISCLAIMER: JACKPOT! is NOT a Lottery Program and no lottery tickets are sold. This is a **Private Club** where participants who play the Lottery send or receive lottery ticket and cash **GIFTS** to/from other Club participants. Void where prohibited by law. Gambling problem? Call: 1-800-522-4700 www.ncpgambling.org National Problem Gambling Helpline ©GPM2023.



<https://o-trim.co/>

LottodayWithTracyLindsey

**Lottoday Gaming NFTs How To
Earn Revenue Share From
Global Lottery Up To 10X
Payout! (\$10M Sold Out)**

**Contact: Tracy ID 2288456
(816) 226-8946**

August 2023

The 10 Best High-Yielding Dividend Stocks For 2023

Finding Value And Returns In A No-Growth Environment



**Quality Dividend Stocks
Never Go
Out Of Style**

**Get All 10-Stocks
With a 10-Page Report
About Them!**

Only \$5.00 To:

Steve Chokanis

6285 W. 10th. Ave. Hialeah, FL 33012

We can also take Pay-Pal payments at

eaglescout88750@att.net

Q's 305-558-8430



THE CASH MACHINE

50% Cash Commission

Auto Pay

Flood your mailbox with cash & stamps.

Choose the level you are joining at:

- You pay \$1,000 + 1,000 F/C Stamps.
20 Sign-Ups pays \$10,000 + 10,000 stamps
- You pay \$3,000 + 3,000 F/C Stamps.
20 Sign-Ups pays \$30,000 + 30,000 stamps.
- You pay \$5,000 + 5,000 F/C Stamps.
20 Sign-Ups pays \$50,000 + 50,000 stamps.

Check the box of your choice.

**We mail 10,000 of these flyers when we
receive orders with your ID # 986**

William Marshall

PO Box 230751 Boston, MA 02123

Get Several of These Bills One At A Time One Day At A Time

Earn \$20.00 Cash for Collecting Names for Us!



**THIS
OFFER is for
CASH ONLY!**

PLUS Receive \$100.00 Bills from a one-time \$100.00 Gift to our \$100 Cash Recession Buster Mail Order Concept!

*Mail This \$20 Flyer for us and
Receive Hundreds of these \$20
Bills for Securing Names for us!*

Our \$100 Cash Recession Buster Concept

1. You don't need a Business or Company Name.
2. Not required to get a Business License.
3. You don't have to collect or pay any Sales Tax.
4. You don't have any Payroll Checks to hand out.
5. You don't have to pay any Business Taxes.
6. You won't even need a Business Address.
7. You can do this in the privacy of your own home.
8. You can do it Locally, Statewide or Nationwide.
9. Your Family GETS all the CASH Money when or if you become Disabled.
10. You have absolutely no Income Tax to File or Pay
11. You would ONLY Receive Cash US Dollars.
12. No Checks to CASH. No Money Orders to CASH.
13. Get Rich at your own pace ~ Helping Others Get Rich!



(All This from A One Time \$100 CASH GIFT)



Send \$20 Cash and 5 f/c Stamps for \$20 Dealership:

Return This Flyer, \$20 + 5 stamps and your name on a label to receive this \$20 All-Profit Dealership! (03)

Barry B. Mann
P.O. Box 497 ~ Bell Buckle TN 37020

DEALER KEEPS ALL THE MONEY!
Send This Flyer, 5 f/c Stamps and Customer's Name & Addr. Label

WEEKLY PRINT & MAIL SPECIAL

32,000 Total Circulation

Your 8x11” Circulars 1 or 2 sided

- 4 Weeks 8,000 Cir \$150 + 150 F/C Stamps**
- 8 Weeks 16,000 Cir \$300 + 300 F/C Stamps**
- 12 Weeks 24,000 Cir \$450 + 450 F/C Stamps**
- 16 Weeks 32,000 Cir \$600 + 600 F/C Stamps**

Bonus #1: Send for 8 weeks or more. You can join my Best Program FREE

Bonus #2: Send up to 5000 of your postcards to be mailed with this special FREE.

C/Copy Sent

**Please use Priority Mail &
U. S. Postal Money Orders Only.**

William Marshall

**P O Box 230751
Boston, MA 02123**

August 2023

Another Ultimate MAIL ORDER Concept



PLUS 9 Secrets For Selling "Big Mails"

A CENTURIES OLD MAIL ROOM CONCEPT!

TURN YOUR TIME INTO PROFITS!



THIS OFFER is for CASH ONLY!



- Learn How To Get Paid to Send Big Mails Out FREE
- Learn How To Use your Big Mail to Make Big MONEY
- Learn How and What To Add to your Big Mail
- Learn How To Co-Publish Adsheets and Magazines
- Learn How To Use Commission vs All Profit Circulars
- Learn How To Build and Sell your very own Name List
- Learn How To Get FREE Names to Mail Opportunities to
- Learn How To Use your Big Mail to Save Bigger MONEY
- Let the MAIL ROOM put Your Business in the Profit Zone
- Learn How to Add a 100 Circulation Printing & Mailing
- It's Like Starting Your Biz all over again but with Profits

When YOU Have "The \$20 Mail Room", You have the Ultimate Mail Order Control over your new and exciting Business. Yes, The \$20.00 Mail Room Makes your Biz a brand new Adventure Plus you can pocket \$10.00 Cash for each new name you get for our name list. The PS fills your orders for \$10.00 plus the 5 f/c Stamps.

Send this flyer, \$20.00 Cash and 5 f/c Stamps for Your \$10.00 dealership to the \$20.00 Mail Room
PLEASE PRINT YOUR NAME AND ADDRESS LIKE YOU WANT IT ON YOUR FLYER

Name _____
Address _____
City/State/Zip _____

INSTRUCTIONS: (Dm-10)
Put 5 f/c stamps & \$20 Cash in a small envelope and wrap a copy of this flyer around it and mail it to the Dealer below.

DIAMOND
POB 51025
Albany GA 31703

Discount First Class Postage Stamps

**100 First Class Stamps
Only \$39**

**How To Order:
Send Money Order
or use Zelle**

llemus3928@gmail.com

Send To:

Lorena Lemus

**245 N Valencia Bl. PMB 137
Woodlake, CA 93286**

llemus3928@gmail.com

Learn How to Profit from the Ultimate Label Marketing System

If you are in direct mail or even thinking about getting into it. The one thing you will definitely need will be Return address labels.

We have developed a system that can help you create a side income while you are building your primary income and for those of you that don't have an offer right now can use this one as your primary. Many successful businesses use other sources of marketing to help them create on-going cash flow. Direct mail marketers can now do the same!

Return this flyer to the address below. **Include your name and address with \$37 CASH ONLY checks and money orders will be sent back.** Conceal the cash flat (**not folded**) in dark paper and enclose in an envelope you cannot see through. **Tape the seal of the envelope.**

Your order is forwarded as a commission to the 3 people in your upline, whose IDs are in the Enrollment Code below (**\$30 total**) The \$7 helps the monitor cover the cost of 120 labels with your personal information on them, your master copy of this flyer, tips for direct mail success and info on our NEW ULMS 2.0 Upgrade that can put cash in your pocket consistently every month. **(For faster delivery, add \$6 for priority)**

You must qualify to receive commissions every month with at least ONE order (\$15 minimum) of labels. This will also qualify you for our **TEAM CO-OP (information about this will be in your packet) AND** allow you to receive on-going commissions from your personal dealer's monthly order! In turn, your uplines will receive your flyer and be encouraged to mail the flyer with both of your IDs on it. **This will help you receive your commissions faster!**

As buyers begin to enroll as dealers -- ***\$12 commissions are paid in position 1, \$10 are paid in position 2 and \$8 are paid to position 3.*** You will also receive all your dealers information. Your ID multiplies through 3 levels on the flyers in your downline. With only 2 dealers enrolled through each level **you** could earn **\$170 in commissions.** $2(\$12) + 4(\$12) + 8(\$12)$. **OVER 100% PROFIT FROM YOUR FIRST MAILING.**

You can ONLY IMAGINE how much you could earn, as everyone enrolled in your downline does the same.

Example earnings using just 1st position:

$$4(\$12) + 16(\$10) + 64(\$8) = \$1,008$$

$$6(\$12) + 36(\$10) + 216(\$8) = \$3,096$$

$$8(\$12) + 64(\$10) + 512(\$8) = \$7,008$$

The Potential is staggering! All from a mailing label! **ITS JUST THAT SIMPLE.**

DDS MARKETING SERVICES

867 N. 28th Ave

Cornelius, Or 97113

Label Marketing System – 1108 – 1070 - 1069

If You See This Flyer ANYWHERE

Receive Thousands of

FREE



U.S. Postage Stamps

Remember, you may never have to buy another stamp

I will show you how to get Thousands of FREE POSTAGE STAMPS FOREVER!
The initial cost is trivial when you compare it to

Thousands of FREE Postage Stamps!!!



To receive the 2 reports "Twenty-One Envelope Tricks" and "How to Get Thousands of FREE Postage Stamps Forever"

Plus this camera-ready circular typeset with your info

Return this Flyer with one Book of (20) first class stamps for Setup!



NAME _____
ADDRESS _____
CITY _____
STATE/ ZIP _____

is Ready To Ship
To YOU !!

Barry L. Mann
P.O. Box 497
Bell Buckle TN 37020



Please Return It

With 1 Book of FOREVER Stamps To:

Barry L. Mann

P.O. Box 497 ~ Bell Buckle TN 37020

The *Ultimate* **MAIL ORDER PROFIT**

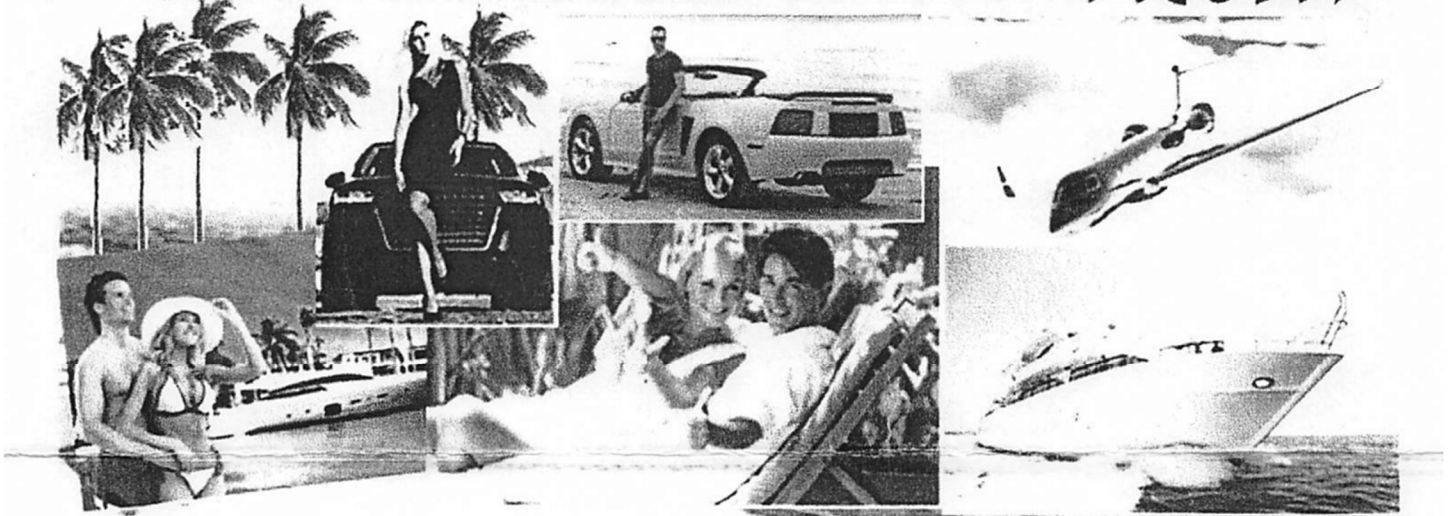

Say "Hello" to a New Way of Life!

10,000 Flyers Mailed For You FREE On All 3 Levels!

When you join us: We Print & Mail 10,000 Flyers Like This (One Time) with Your Name And Address in #1 Position. When Prospects Join, We Print & Mail 10,000 Flyers for Them FREE with Your Name In Position #2. Your Flyer Keeps Getting Mailed To 10,000 Again and Again when you are in Position #1, Position #2, and Position #3, (10,000 One Time Only). **NOTICE:** ACE LANFRANCO's 120,000 Printing and Mailing has not produced any responses at all. So we are changing the P&M to 10,000 !

10,000 FLYERS COULD BE PRINTED AND MAILED WITH YOUR NAME IN THE #1, #2 AND #3 POSITIONS !

Level 1 - I print & mail 10,000 for everyone. If everyone gets 1/10 of a 1% response -- That's 10 people x \$100 = \$1,000.00

Level 2 - These 10 do the same and get 10 each with you in #2 Position -- That's 100 New people x \$100 = \$10,000.00.

Level 3 - These 100 do the same and get 10 each with you in #3 Position -- That's 1,000 New people x \$100 = \$100,000.00

(Possible) GIFTS = \$111,000+/- Advertise every month and You could do better than this each month



YOUR NAME ON 10,000 FLYERS, BRINGING YOU \$100 CASH GIFTS!

ALL \$100 CASH GIFTS COME TO YOUR FRONT DOOR or Your Mailbox.

No orders to fill, No Checks to cash. All Envelopes come with \$100 Cash.

Send \$100 CASH and a flyer to each Member listed Below, and to the Monitor.

The \$100 Cash is a free GIFT to the 3 members to help with the Rising Living Costs.

Send CASH Only! No Checks. Put your \$100 Cash in a small envelope with name label. Must include a copy of flyer and mail them in a #10 Envelope.

SEND \$100 CASH TO THE MONITOR: Larry L. Mann ♦ P.O. Box 497 ♦ Bell Buckle, TN 37020

#1. SEND \$100 CASH To: William Caufield 1600 W Lawndale #203 San Antonio TX 78209

#2. FREE SPACE -- NO ONE HERE -- SAVE \$100

#3. FREE SPACE -- NO ONE HERE -- SAVE \$100

Your \$100 is a Gift, so we do not demand nor verify payments. (Cheaters will lose free P&M)

All Rights Reserved without Prejudice UCC 1-308, LLM, 2018 Disclaimer: No guaranteed amount of Gifts. (Dm-umop)

(Please Print your name & address clearly on the small envelope containing your \$100 cash as you want it listed on your flyer)



SOLD ONLY IN THE USA

Super



THIS OFFER is for CASH ONLY!

Lifetime Big Mail

You KEEP All the MONEY and Fill the orders yourself. Start your own Profitable Big Mail Business, Name List Business and Print & Mail on their money!

Enough Exciting and Adventurous Opportunities to keep you in a Mail Order Business and Cash Money for a Lifetime!

Warehouse of Opportunities

PLUS 9 Secrets for Making Money Selling Big Mail

Round up all the Best Opportunity Offers you have along with Adsheets and other people's Print & Mail Orders and mail them out to the people who pay you for your Big Mail of Opportunities.

This is a 50% Program that lets you keep \$10.00 of the money and fill the orders with YOUR Own Big Mail Opportunities. If you don't have a Big Mail ready, Keep \$10 and send the other \$10 and all 5 f/c Stamps to the PS so he can fill your orders for you. Plus receive the 9 Big Mail Secrets!

SEND \$20 AND 5 F/C FOREVER STAMPS

Name _____
 Address _____
 City/ ST/ Zip _____

(Dm-8)

DIAMOND
 POB 51025
 Albany GA 31703



2022 Money Pages Directory CD-ROM

- **500+ Awesome Money Making Listings**
- **Tons of High Income Dealership Offers**
- **Dozens of Discount Advertising Deals**
- **Top Online Wealth Generating Programs**
- **The Best Business Opportunities In Mail Order**

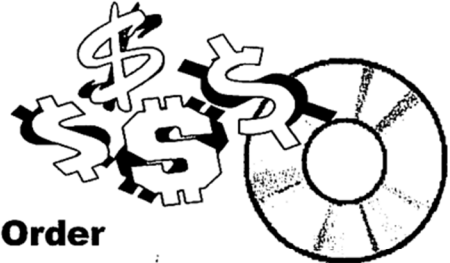

Includes 20 Of The Best Money Making Ebooks That You Can Learn From To Enhance Your Money Making IQ As Well As Resell For **100% Profits!**

The **New 2022 Money Pages Directory CD** Also Includes This 100% Order Grabbing Commission Circular! You Will Make Easy Unlimited **\$20.00 Commissions Per Order!** The Prime Source Will Fill Orders For You For Just The \$3.00 Shipping Fee! It Can't Get Any Easier For You To Make Extra Money With This **Ready-To-Go** 100% Done For You Money Circular!

The Market For The 2022 Money Pages Directory CD is Simply **HUGE** and The \$20.00 Commissions Can Really Add Up **FAST!** How Much Extra Do You Want To Make?...

Selling This All-Profit CD Could Potentially Bring In A Nice Additional Income Stream For You In The \$100's

Of Extra Dollars Per Week This Year Alone! ***It's Obviously a No-Brainer!***

Bonus To First 50 Orders! Receive A Buy One Get One FREE Discount Offer For Your Very Own Full Page Ad(s) in The '2022 Money Pages Directory CD', You'll Get BIG, Steady, Consistent, Highly Targeted and Responsive Circulation in The Thousands To Your Offers For Many Years To Come... All For A One Time Fee!

For your copy of the new '2022 Money Pages Directory CD' along with a copy of this 100% commission circular + Bonus BOGO Offer, send just \$20 + \$3 (\$23 Total) by cash, check, or money order (10 day wait for bank clearance with check payment) immediately to:

William Caufield
1600 W. Lawndale Dr. #203
San Antonio, TX 78209

The Ultimate **MAIL ORDER** Concept



Say "Hello" to a Centuries Old Concept! 10,000 Flyers Mailed For You FREE On All 3 Levels!

When you join us: We Print & Mail 10,000 Flyers Like This (One Time) with Your Name And Address in #1 Position. When Prospects Join, We Print & Mail 10,000 Flyers for Them FREE with Your Name In Position #2. Your Flyer Keeps Getting Mailed To 10,000 Again and Again when you are in Position #1, Position #2, and Position #3, (10,000 One Time Only). **NOTICE:** There is no guarantee on the Printing and Mailing response you may receive as there are too many things that change the results !

10,000 FLYERS COULD BE PRINTED AND MAILED WITH YOUR NAME IN THE #1, #2 AND #3 POSITIONS !

Level 1 - I print & mail 10,000 for everyone. If everyone gets 1/10 of a 1% response - That's 10 people x \$100 = \$1,000.00

Level 2 - These 10 do the same and get 10 each with you in #2 Position - That's 100 New people x \$100 = \$10,000.00.

Level 3 - These 100 do the same and get 10 each with you in #3 Position - That's 1,000 New people x \$100 = \$100,000.00

(Possible) GIFTS = \$111,000+/- Advertise every month and You could do better than this each month

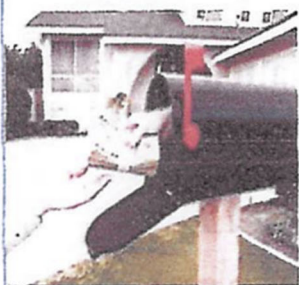

YOUR NAME ON 10,000 FLYERS, BRINGING YOU \$100 CASH GIFTS!

ALL \$100 CASH GIFTS COME TO YOUR FRONT DOOR or Your Mailbox.

No orders to fill, No Checks to cash. All Envelopes come with \$100 Cash.

Send \$100 CASH and a flyer to each Member listed Below, and to the Monitor.

The \$100 Cash is a free GIFT to the 3 members to help with the Rising Living Costs.

Send CASH Only! No Checks. Put your \$100 Cash in a small envelope with name label. Must include a copy of flyer and mail them in a #10 Envelope.

SEND \$100 CASH TO THE MONITOR: Larry L. Mann ♦ P.O. Box 497 ♦ Bell Buckle, TN 37020

#1. SEND \$100 CASH To: DIAMOND P. O. BOX 51025 ALBANY GA 31703

#2. FREE SPACE -- NO ONE HERE -- SAVE \$100

#3. FREE SPACE -- NO ONE HERE -- SAVE \$100

Your \$100 is a Gift, so we do not demand nor verify payments. (Cheaters will lose free P&M)

All Rights Reserved without Prejudice UCC 1-308, LLM, 2018 Disclaimer: No guaranteed amount of Gifts. (Dm-umop)

(Please Print your name & address clearly on the small envelope containing your \$100 cash as you want it listed on your flyer)

WIN! WIN! WIN! WIN! WIN!

ALL THE TIME!

Every time you purchase a lottery ticket you have an opportunity to WIN! This program was developed to help you get Instant win/Scratch off lottery tickets!

Send 5 One Dollar Scratch off lottery

Tickets and \$5.00 cash with this cir-

cular to the person whose name is in

the "Authorized Dealer" box below.

You will receive a copy of this circu-

lar with space for your name and ad-

dress in the "Authorized Dealer" box.

Then print & mail copies of the circular and soon you will have cash and lottery tickets in your mail box!

There is no "Middle man" - No "Monitor" - You keep all of the cash and all of the lottery tickets. To fill the order all you have to do is send a copy of this circular to your ticket and cash donor with a blank space for their name and address.

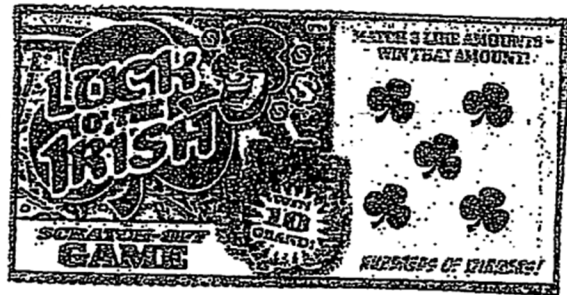

Do it today! Get started winning!

Name _____

Address _____

City _____

State _____ Zip _____

Authorized Dealer:- William Caufield 1600 W Lawndale Dr #203 San Antonio, TX 78209

24-HR RECORDED MESSAGE!
CALL 909-200-2880

Postcard
stamp

**TIRED OF LIVING PAYCHECK TO PAYCHECK?
Earn EXTRA Income From The Comfort Of Your Home.**

**FREE Postcards!
FREE Starter Kit!
FREE Names!**



Address label goes here.

**Get Paid Up To
5 Times A Month!**

BY FAR THE EASIEST HOME-BASED BUSINESS!

"Within 6 months, my monthly check was bigger than my Air Force retirement check after 20 years of service." — D. Evans

**FINALLY, A SIMPLE HOME-BASED BUSINESS!
FREE Starter Kit ~ FREE Postcards ~ FREE Names!**

Are you looking for an Easy, Honest and Ethical way to make an extra \$1,500 to \$10,000 a month from home? If so, then join Life Force International and cash-in on the Multi-Billion Dollar Nutrition Industry!

No Selling! ~ No Meetings! ~ No Computer Needed!

ALL YOU DO IS MAIL THIS POSTCARD and use our nutritional product. We've reserved a FREE Start-up Kit for you, which includes a coupon to request your **250 FREE** postcards and **250 FREE** names. We will also show you how to receive additional **FREE** postcards every month!

Life Changing Product: TrueGreens is a vegan super-food combination of greens, grains, fruits, vegetables, noni probiotics and enzymes. It is like a "Salad Bar" in a Jar.

Unlimited Income Potential: You'll earn a whopping 55% commission on your first 3 levels of pay. Plus additional bonuses on unlimited levels. Would an extra \$1,500.00 to \$10,000.00 a month change your life? Ordinary people are earning **Full-Time** incomes with **Part-Time** effort.

I want to make EXTRA money from home. Enroll me in Life Force and rush my **FREE** Start-Up Kit, and the coupon to request my 250 **FREE** postcards and 250 **FREE** names.

Name: _____

Address: _____

City: _____

State: _____ Zip: _____

Phone: _____ Required

Email: _____ Optional!

Return the completed postcard to:

**New Dimensions 50K Team
P.O. Box 969 ~ Grayson, GA 30017**

ID#: **3 0 0 3 2 2 9 0**

24-HR RECORDED MESSAGE! CALL- 909-200-2880

6800 First Class Stamps!

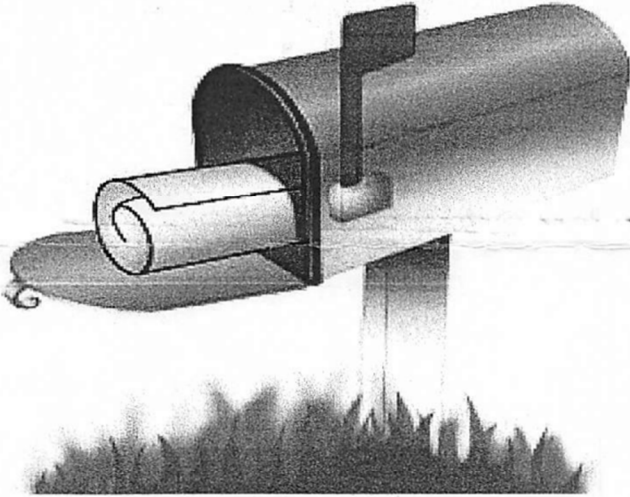

**Quickly generate postage for
your direct mail business.**

**Mail this ad until you sponsor
4 people. You don't have to do
anything else.**

**DO NOT SEND ANY MONEY!
This offer is for
First Class Stamps only.**

Name.....
Address.....
City.....State.....
Zip.....

**Print clearly or use label.
Do not alter this ad in any way.
Do not put tape on any stamps you send.**

**This ad is a proven winner.
Include this ad in your outgoing mail.**

**Use this ad to create a steady stream of
First Class Stamps.**

**Send a copy this ad with 1 book of 20
Forever Stamps to everyone below.**

**Monitor:
E J Dover
PO Box 1358
VA Bch, VA 23451**

**1. William Caufield
1600 W Lawndale Dr #203
San Antonio, TX 78209**

2. Free Space

3. Free Space

4. Free Space

**The monitor will send you 2 Color Master
Copies of this ad with your name listed in
the #1 spot, and the others moved down.
You will also get 120 Fresh Names on peel
and stick labels and 1 set of Color Teaser
Labels for your envelopes.**

**Sponsor 4 people-you get 4 books of stamps
When those 4 sponsor 4 each-you get 16 books
When those 16 sponsor 4 each-you get 64 books
When those 64 sponsor 4 each-you get 256 books
340 books=6800 Stamps!**

**Once you set this thing in motion
you won't be able to stop it!**



1,000's of Super Hot Money Makers Now on ONE Jammed-Packet CD-Rom!

The Harris Infoserve Disk Catalog

◀ASTOUNDING!▶

**Over Half A Gigabyte Of High Demand
Information!**

**Over a \$1,000 Of Catalog Value At A Give
Price! The steal of the decade!**

**OVER 16,500 TITLES PLUS 1,000'S OF
SHAREWARE PROGRAMS. 525+FLOPPY DISKS
NOW JAMMED PACKETED IN THIS CD.**

This is not just all information, it is also a Business in a Box Fit
Onto a Floppy Disk Ready For YOU!!

**All the work has been done for you - nothing comes
anywhere near the size and scope of this CD ROM. One of
the best in the world is now available for you to make
BIG TIME MONEY!**

**Just about every Topic under the sun covered!
Something for everyone!**

For your very own copy of "The Harris Infoserve Disk Catalog"
Rush one time payment of only \$40.00 by Money Order To:

**Wright's Co. PO Box 1886
Horsham PA 19044
(215) 833-9905**

Printing & Mailing Services



**MAKE \$1000'S WEEKLY WITH
OUR POWERFUL PRINT AND
MAIL MONEY MAKING
PROGRAM!**

I CAN PRINT AND MAIL 10,000 FLYERS A MONTH!!!

Dear Mailer,

Please **STOP** wasting your money on **BAD DEAD LISTS!** You are receiving this letter from me because you are in mail order. You are mailing a program that **requires fresh leads to make money!**

As you might know I am also in mail order. I am involved in several programs that are doing very well. I am aware of the cost of postage and know that in order to survive in mail order you require good lead sources on a regular basis. ***One bad list can run you out of business!!!***

Through a Network of commission mailers your single sided or double sided flyer can be mailed to over 10,000 money making opportunity seekers within 90 days! When you use our Print and Mail services you also become one of our commission mailers. This gives you an added opportunity to make **a lot of money as a Commission Mailer and a Print and Mail Program Distributor!**

WHAT YOU DO NOW! Get started by making a Certified Check, Money Order or Cash for \$200 Payable to each Distributor listed below:

- (\$200) 1. James Duncan, 871 Caney Branch Road, Morrison, TN 37357**
- (\$200) 2. Jon Okafo, 5208 Hadrian Drive, Durham, NC 27703**
- (\$200) 3. FREE.....No One Here Yet (You save \$200).....**

Please include a copy of your flyer with each payment. Upon receipt of your payments, your flyer will be distributed and mailed by our commission mailers.

You will also receive a copy of this letter with your name in Position #1. This is a Fast Moving 3 Level Program! All you have to do is make copies and collect \$200 payments as your name goes through 3 levels. You never drop out because you will be included in other flyers.

Live calls Every Sat: (681) 999-0266, Pin: 972198#, 1 pm (Eastern)

THIS IS A LEGAL OPPORTUNITY TO MAKE SOME SERIOUS MONEY!